



3-150SL

Carriers

For 2-5 ton loaders

Hydraulics

Flow 65l/m

Pressure 200 bar

Weight

600 Kg

Capacity

0.35m³

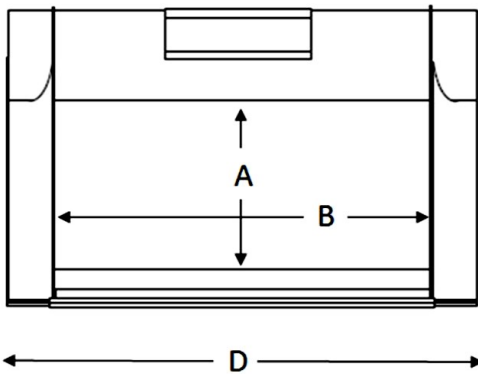

Screening area

430 mm x 1500 mm

Dimensions (mm)

A 430 B 1500

C 500 D 1870

E 760 F 640

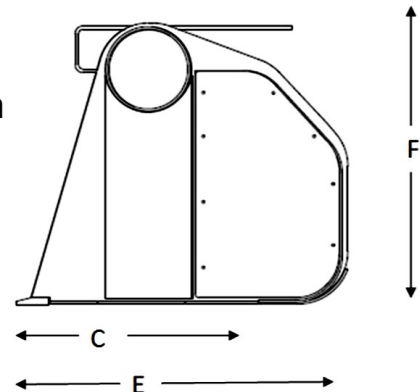

Fast efficient screening systems



True compact screening

Low maintenance bucket

Poly stars which screen without crushing

Large screening area to maximise output